

Anesthesia Breathing Circuit

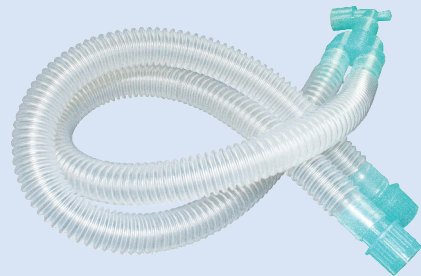

Instructions For Use:

- Peel off the bag, take out the product.
- Check all the connection parts of product, and tighten all the connection.
Avoid leakage or loose when the product be used.
- Test the product and ensure the product compatible with the machine,
and not leakage or blocked.
- If without sampling connection, make sure the sampling ports (such as temperature,
pressure and gas sampling ports) are covered by caps and tighten, to prevent leakage.
- When using the product, please fixing I-piece with anesthesia machine and breathing
machine, L-piece to be connected with the patient.
- When the product working, make sure the patient be closely monitoring.
- Inspection the product regularly during using, if it became contaminated or become no
longer suitable for its intended use, please replace immediately.
- The operator for this product must be trained by professional training.

Name of parts for Anesthesia Breathing Circuit (corrugated)

Anesthesia Breathing Circuit (corrugated)		
Item No.	Name	Material
1	Connector	PP
2	Tube	PP, EVA
3	Water trap	PP, AS, PVC
4	Y-piece connector	PP
5	Elbow	PP
6	Reservoir bag	Latex or latex free
7	Straight connector	PP
8	Anesthesia mask	PC, PVC
9	HMEF	PP

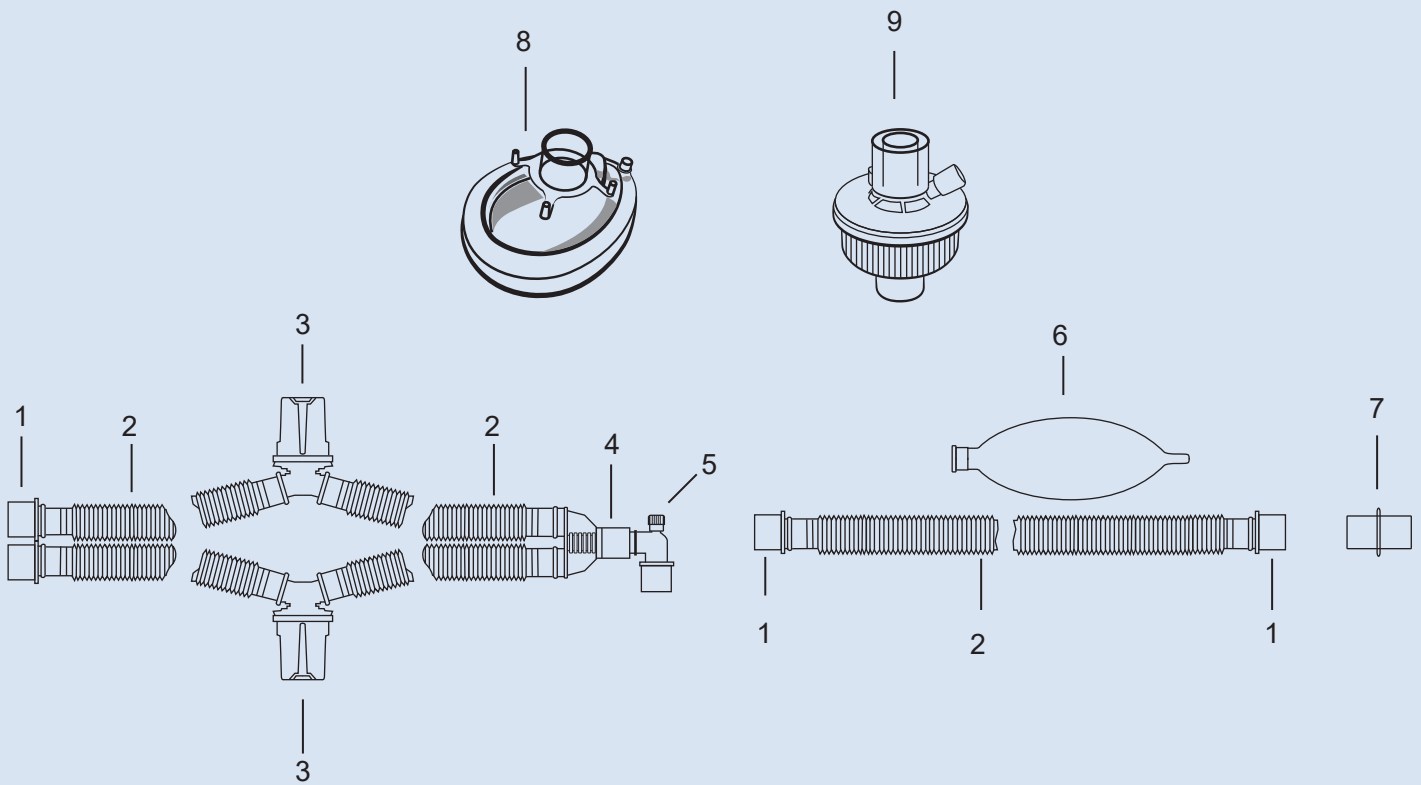

Disposable Corrugated Anesthesia Breathing Circuits

Features:

- Corrugated tubes have a good flexibility and resistance to bend.
- Consist of corrugated hoses, swivel elbow with luer lock port and cap, Y-piece connector .
- Match all kinds of anesthetic and breathing machines.

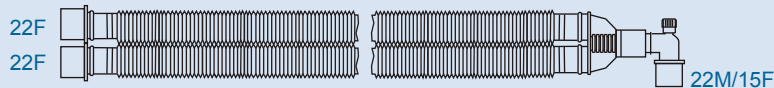
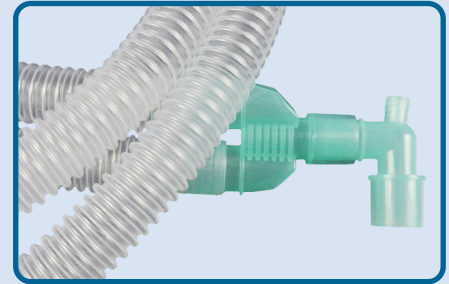

REF: 33-2.4-12B/C	Adult parallel corrugated circuit 2.4M
REF: 33-1.8-12B/C	Adult parallel corrugated circuit 1.8M
REF: 33-1.6-12B/C	Adult parallel corrugated circuit 1.6M
REF: 33-1.2-12B/C	Adult parallel corrugated circuit 1.2M
REF: 263-1.8-12B/C	Pediatric parallel corrugated circuit 1.8M
REF: 263-1.6-12B/C	Pediatric parallel corrugated circuit 1.6M
REF: 263-1.2-12B/C	Pediatric parallel corrugated circuit 1.2M

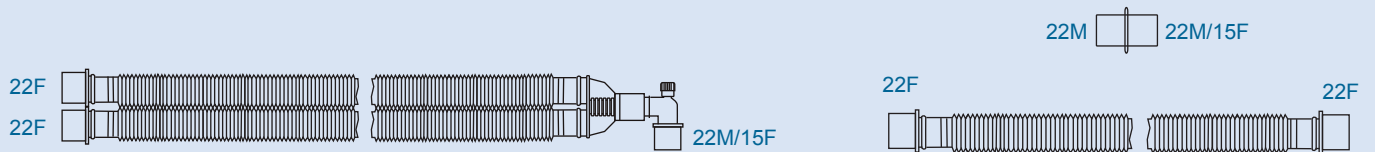

REF: 386-2.4-12B/C	Adult parallel corrugated circuit 2.4M, 0.8 extra limb, 1pc extra connector
REF: 368-1.8-12B/C	Pediatric parallel corrugated circuit 1.8M, 0.8 extra limb, 1pc extra connector



REF: 353-2.4-12B/C	Adult parallel corrugated circuit 2.4M, 2L reservoir bag, 1pc extra connector
REF: 353-1.8-12B/C	Adult parallel corrugated circuit 1.8M, 2L reservoir bag, 1pc extra connector
REF: 353-1.6-12B/C	Adult parallel corrugated circuit 1.6M, 2L reservoir bag, 1pc extra connector
REF: 353-1.2-12B/C	Adult parallel corrugated circuit 1.2M, 2L reservoir bag, 1pc extra connector
REF: 354-1.8-12B/C	Pediatric parallel corrugated circuit 1.8M, 1L reservoir bag, 1pc extra connector
REF: 354-1.6-12B/C	Pediatric parallel corrugated circuit 1.6M, 1L reservoir bag, 1pc extra connector
REF: 354-1.2-12B/C	Pediatric parallel corrugated circuit 1.2M, 1L reservoir bag, 1pc extra connector

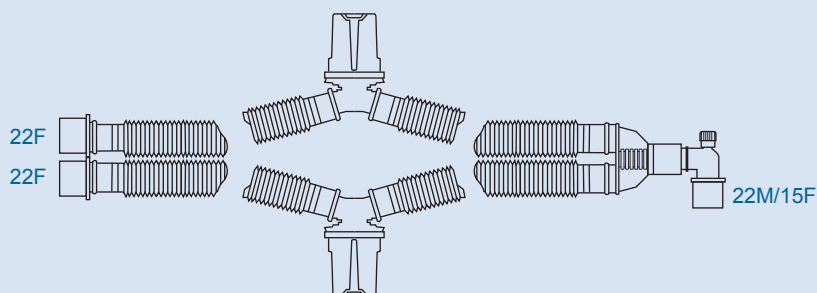

REF: 351-2.4-12B/C	Adult parallel corrugated circuit 2.4M with two water traps
REF: 351-1.8-12B/C	Adult parallel corrugated circuit 1.8M with two water traps
REF: 351-1.6-12B/C	Adult parallel corrugated circuit 1.6M with two water traps
REF: 351-1.2-12B/C	Adult parallel corrugated circuit 1.2M with two water traps
REF: 352-1.8-12B/C	Pediatric parallel corrugated circuit 1.8M with two water traps
REF: 352-1.6-12B/C	Pediatric parallel corrugated circuit 1.6M with two water traps
REF: 352-1.2-12B/C	Pediatric parallel corrugated circuit 1.2M with two water traps

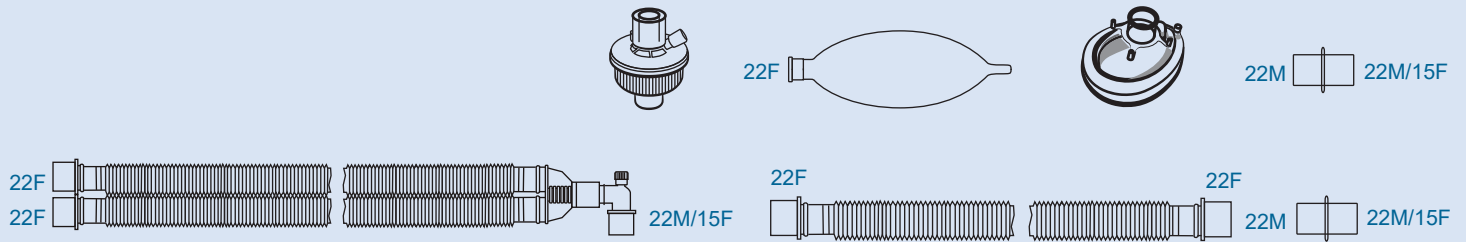

REF: 364-2.4-12B/C

Adult parallel corrugated circuit 2.4M
 2L latex free reservoir bag, 2pcs extra connector, 1pc HME Filter, 1pc
 anesthesia mask 4.0, 1pc 0.8M extra limb

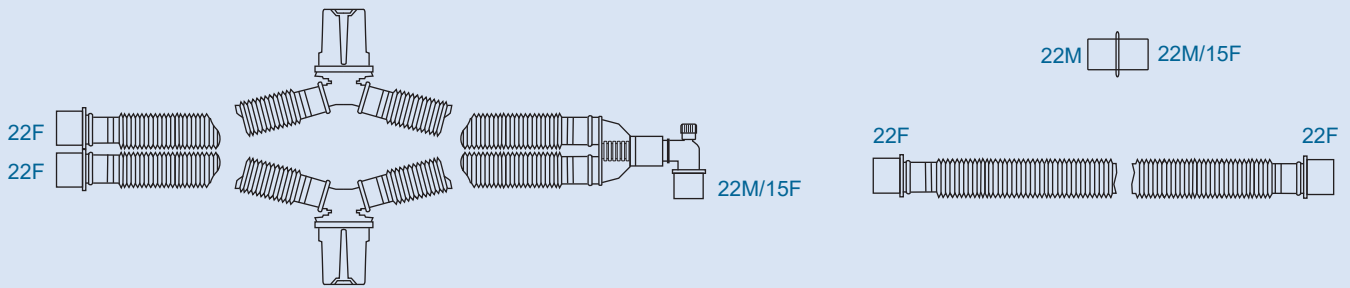

REF: 365-2.4-12B/C

Adult parallel corrugated circuit 2.4M with two water traps,
 1pc extra connector, 1pc 0.8M extra limb

REF: 365-1.8-12B/C

Adult parallel corrugated circuit 1.8M with two water traps,
 1pc extra connector, 1pc 0.8M extra limb

REF: 365-1.6-12B/C

Adult parallel corrugated circuit 1.6M with two water traps,
 1pc extra connector, 1pc 0.8M extra limb

REF: 365-1.2-12B/C

Adult parallel corrugated circuit 1.2M with two water traps,
 1pc extra connector, 1pc 0.8M extra limb

REF: 394-1.8-12B/C

Pediatric parallel corrugated circuit 1.8M with two water traps,
 1pc extra connector, 1pc 0.8M extra limb

REF: 394-1.6-12B/C

Pediatric parallel corrugated circuit 1.6M with two water traps,
 1pc extra connector, 1pc 0.8M extra limb

REF: 394-1.2-12B/C

Pediatric parallel corrugated circuit 1.2M with two water traps,
 1pc extra connector, 1pc 0.8M extra limb

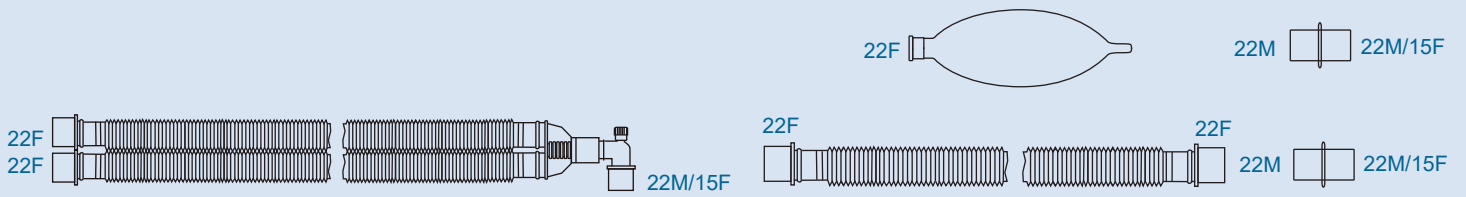

REF: 366-2.4-12B/C

Adult parallel corrugated circuit 2.4M, 2L latex free reservoir bag, 2pcs extra connector, 1pc 0.8M extra limb

REF: 367-1.8 -12B/C

Pediatric parallel corrugated circuit 1.8M, 1L latex free reservoir bag, 2pcs extra connector, 1pc 0.8M extra limb

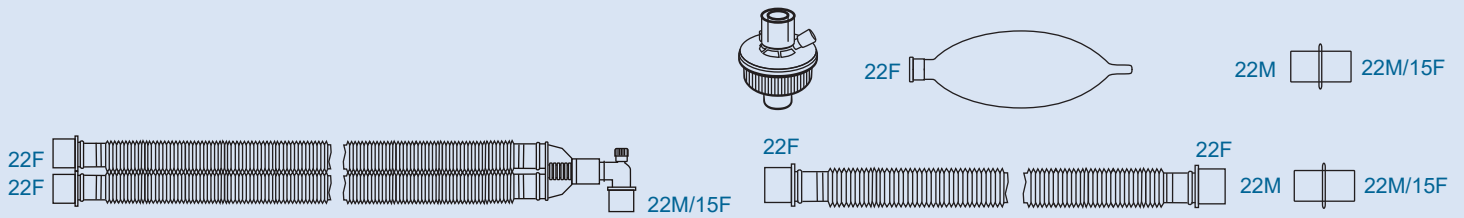

REF: 412-2.4-12B/C

Adult parallel corrugated circuit 2.4M, 2L latex free reservoir bag 2pcs extra connector, 1pc HME Filter, 1pc 0.8M extra limb

REF: 413-1.8-12B/C

Pediatric parallel corrugated circuit 1.8M, 1L latex free reservoir bag 2pcs extra connector, 1pc HME Filter, 1pc 0.8M extra limb

Name of parts for Anesthesia Breathing Circuit (expandable)

Anesthesia Breathing Circuit (expandable)		
Item No.	Name	Material
1	Connector	PP
2	Tube	PP, EVA
3	Water trap	PP, AS, PVC
4	Y-piece connector	PP
5	Elbow	PP
6	Reservoir bag	Latex or latex free
7	Straight connector	PP
8	Anesthesia mask	PC, PVC
9	HMEF	PP

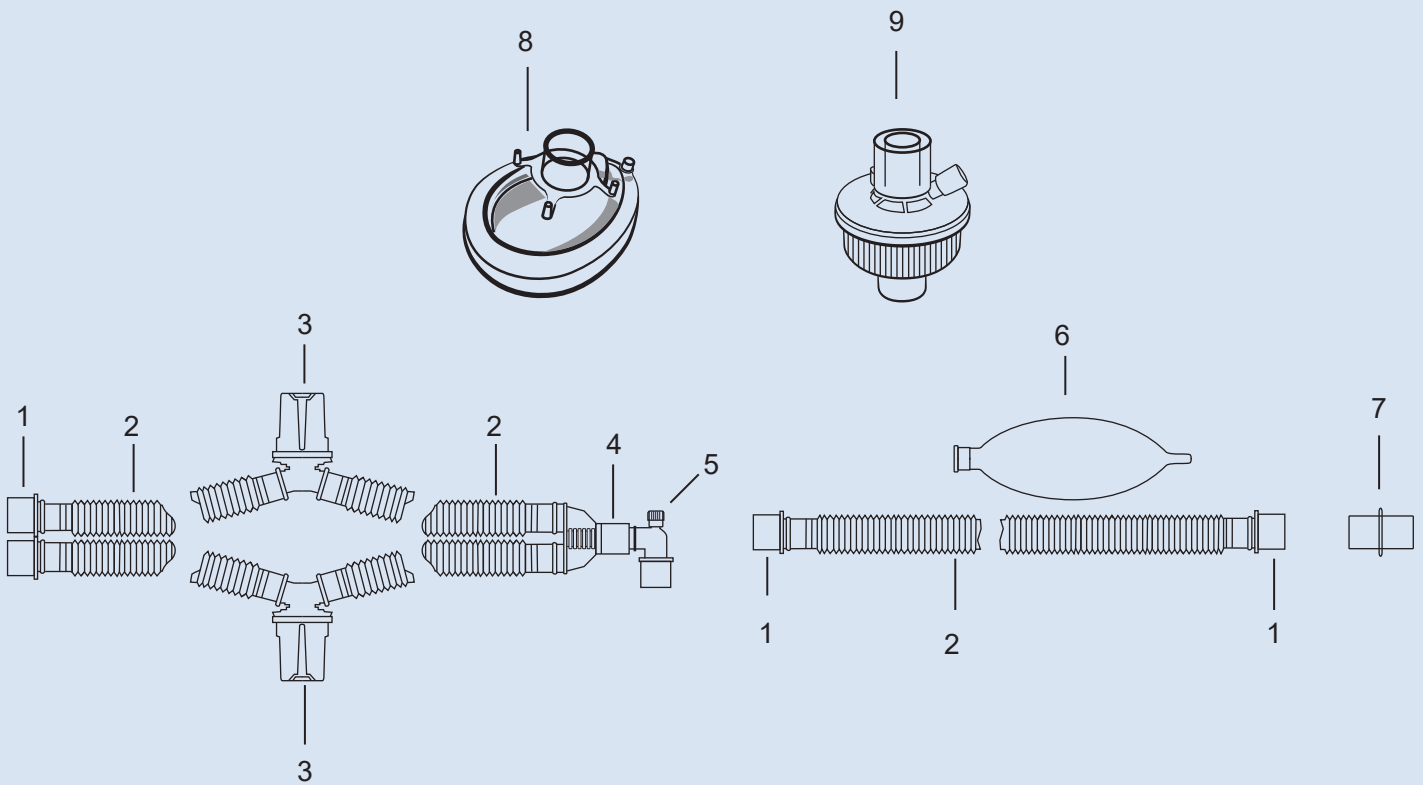

Disposable Expandable Anesthesia Breathing Circuits

Features:

- Adjustable length can significantly save space.
- Expandable tube can be packed more in the package, and will lower freight volume costs.
- Consist of expandable hoses, swivel elbow with luer lock port and cap, Y-piece connector .

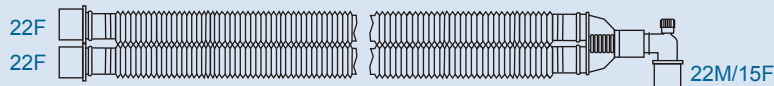
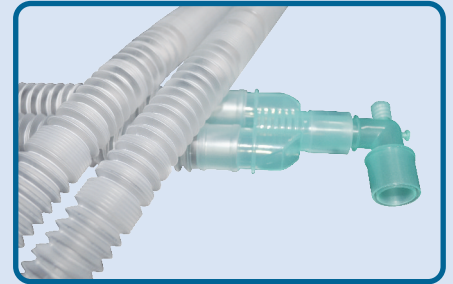

REF: 33-2.4-12B/E	Adult parallel expandable circuit 2.4M
REF: 33-1.8-12B/E	Adult parallel expandable circuit 1.8M
REF: 33-1.6-12B/E	Adult parallel expandable circuit 1.6M
REF: 33-1.2-12B/E	Adult parallel expandable circuit 1.2M
REF: 263-1.8-12B/E	Pediatric parallel expandable circuit 1.8M
REF: 263-1.6-12B/E	Pediatric parallel expandable circuit 1.6M
REF: 263-1.2-12B/E	Pediatric parallel expandable circuit 1.2M

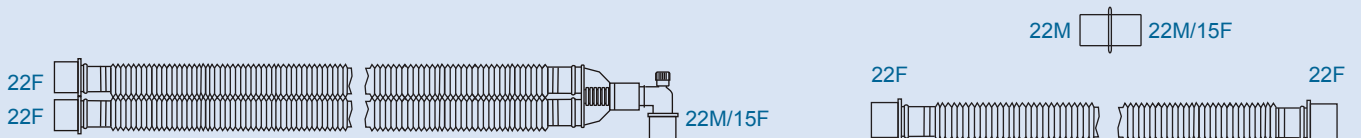

REF: 386-2.4-12B/E	Adult parallel expandable circuit 2.4M, 0.8 extra limb, 1pc extra connector
REF: 368-1.8-12B/E	Pediatric parallel expandable circuit 1.8M, 0.8 extra limb, 1pc extra connector



REF: 353-2.4-12B/E	Adult parallel expandable circuit 2.4M, 2L reservoir bag, 1pc extra connector
REF: 353-1.8-12B/E	Adult parallel expandable circuit 1.8M, 2L reservoir bag, 1pc extra connector
REF: 353-1.6-12B/E	Adult parallel expandable circuit 1.6M, 2L reservoir bag, 1pc extra connector
REF: 353-1.2-12B/E	Adult parallel expandable circuit 1.2M, 2L reservoir bag, 1pc extra connector
REF: 354-1.8-12B/E	Pediatric parallel expandable circuit 1.8M, 1L reservoir bag, 1pc extra connector
REF: 354-1.6-12B/E	Pediatric parallel expandable circuit 1.6M, 1L reservoir bag, 1pc extra connector
REF: 354-1.2-12B/E	Pediatric parallel expandable circuit 1.2M, 1L reservoir bag, 1pc extra connector

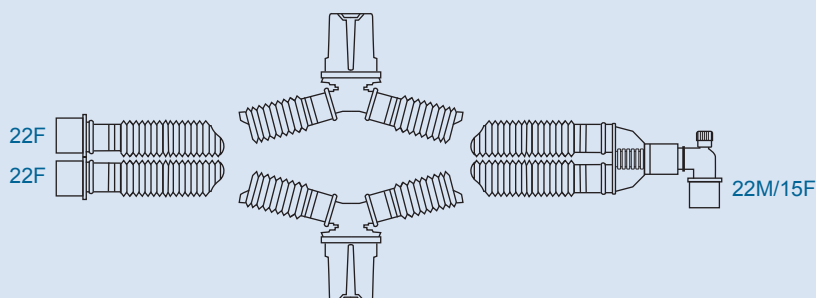

REF: 351-2.4-12B/E	Adult parallel expandable circuit 2.4M with two water traps
REF: 351-1.8-12B/E	Adult parallel expandable circuit 1.8M with two water traps
REF: 351-1.6-12B/E	Adult parallel expandable circuit 1.6M with two water traps
REF: 351-1.2-12B/E	Adult parallel expandable circuit 1.2M with two water traps
REF: 352-1.8-12B/E	Pediatric parallel expandable circuit 1.8M with two water traps
REF: 352-1.6-12B/E	Pediatric parallel expandable circuit 1.6M with two water traps
REF: 352-1.2-12B/E	Pediatric parallel expandable circuit 1.2M with two water traps

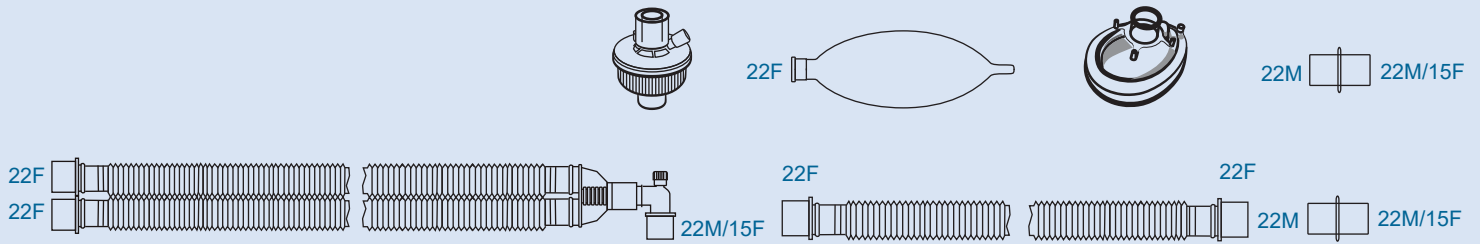

REF: 364-2.4-12B/E

Adult parallel expandable circuit 2.4M
 2L latex free reservoir bag, 2pcs extra connector, 1pc HME Filter, 1pc
 anesthesia mask 4.0, 1pc 0.8M extra limb

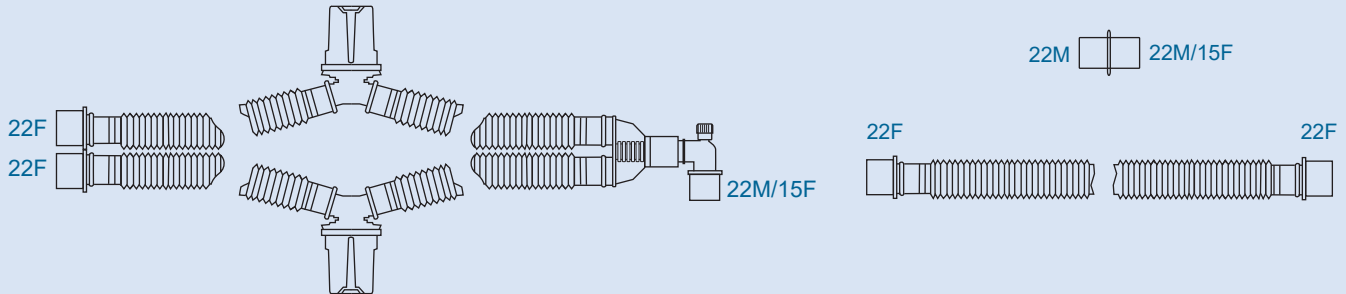

REF: 365-2.4-12B/E

Adult parallel expandable circuit 2.4M with two water traps,
 1pc extra connector, 1pc 0.8M extra limb

REF: 365-1.8-12B/E

Adult parallel expandable circuit 1.8M with two water traps,
 1pc extra connector, 1pc 0.8M extra limb

REF: 365-1.6-12B/E

Adult parallel expandable circuit 1.6M with two water traps,
 1pc extra connector, 1pc 0.8M extra limb

REF: 365-1.2-12B/E

Adult parallel expandable circuit 1.2M with two water traps,
 1pc extra connector, 1pc 0.8M extra limb

REF: 394-1.8-12B/E

Pediatric parallel expandable circuit 1.8M with two water traps,
 1pc extra connector, 1pc 0.8M extra limb

REF: 394-1.6-12B/E

Pediatric parallel expandable circuit 1.6M with two water traps,
 1pc extra connector, 1pc 0.8M extra limb

REF: 394-1.2-12B/E

Pediatric parallel expandable circuit 1.2M with two water traps,
 1pc extra connector, 1pc 0.8M extra limb

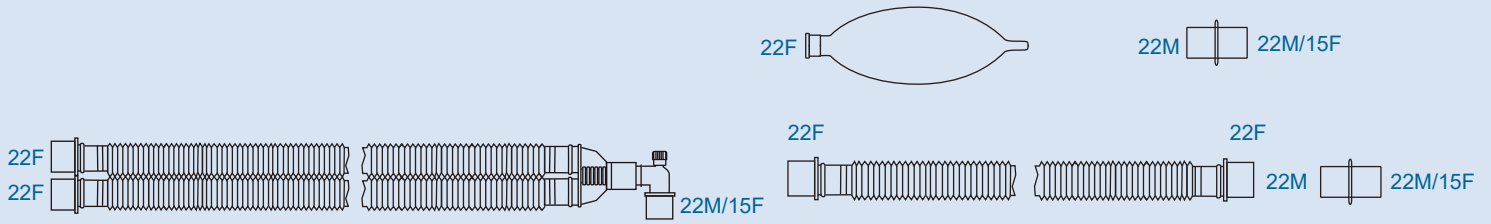

REF: 366-2.4-12B/E

Adult parallel expandable circuit 2.4M, 2L latex free reservoir bag, 2pcs extra connector, 1pc 0.8M extra limb

REF: 367-1.8 -12B/E

Pediatric parallel expandable circuit 1.8M, 1L latex free reservoir bag, 2pcs extra connector, 1pc 0.8M extra limb

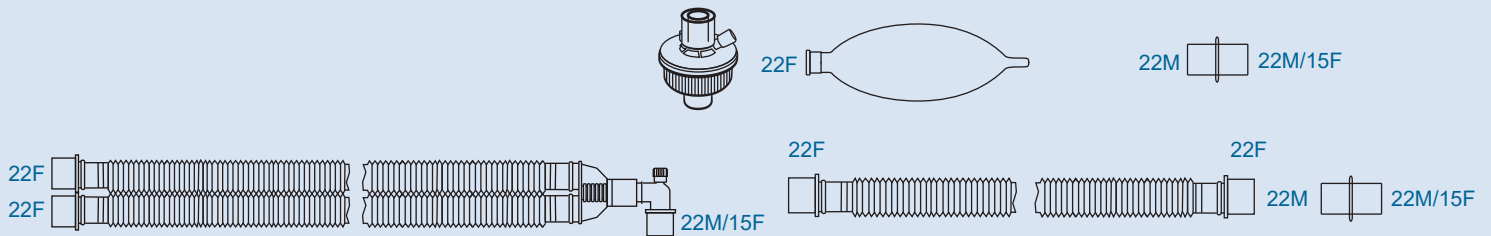

REF: 412-2.4-12B/E

Adult parallel expandable circuit 2.4M, 2L latex free reservoir bag
2pcs extra connector, 1pc HME Filter, 1pc 0.8M extra limb

REF: 413-1.8-12B/E

Pediatric parallel expandable circuit 1.8M, 1L latex free reservoir bag
2pcs extra connector, 1pc HME Filter, 1pc 0.8M extra limb

Name of parts for Anesthesia Breathing Circuit (smoothbore)

Anesthesia Breathing Circuit (smoothbore)		
Item No.	Name	Material
1	Connector	PP
2	Tube	PVC
3	Water trap	PP, AS, PVC
4	Y-piece connector	PP
5	Elbow	PP
6	Reservoir bag	Latex or latex free
7	Straight connector	PP
8	Anesthesia mask	PC, PVC
9	HMEF	PP

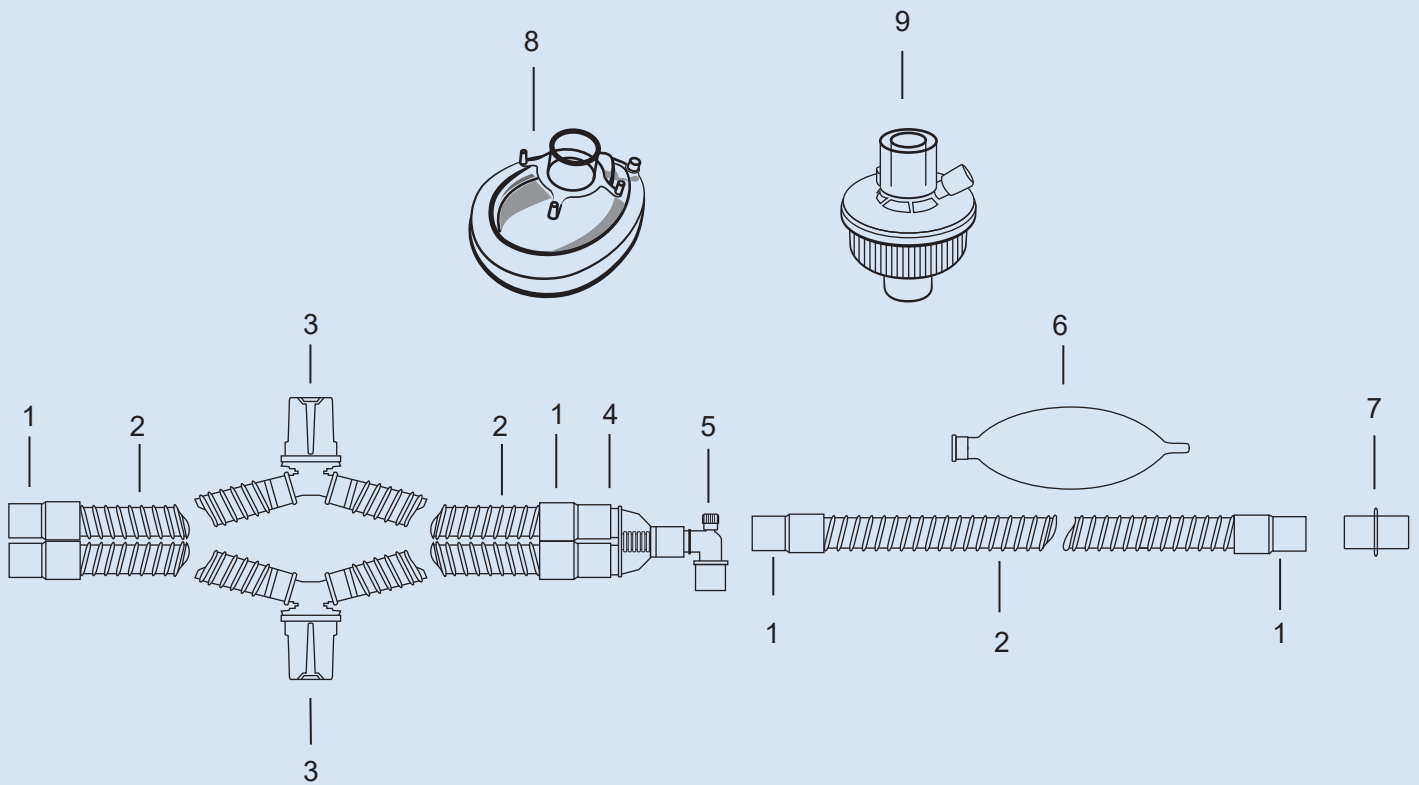

Disposale Smoothbore Anesthesia Breathing Circuits

Features:

- Consist of smoothbore hoses, swivel elbow with luer lock port and cap, Y-piece connector .
- Smoothbore breathing systems incorporate flexible end connectors at the machine end and light weight rigid connectors within the system offering improved ventilator support.
- The smoothbore tube can improve flow characteristics and lower tubing compliance.

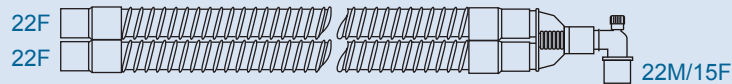
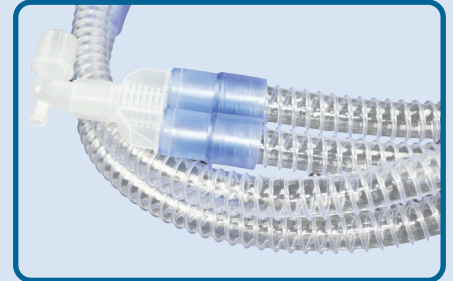

REF: 33-2.4-12B/S	Adult parallel smoothbore circuit 2.4M
REF: 33-1.8-12B/S	Adult parallel smoothbore circuit 1.8M
REF: 33-1.6-12B/S	Adult parallel smoothbore circuit 1.6M
REF: 33-1.2-12B/S	Adult parallel smoothbore circuit 1.2M
REF: 263-1.8-12B/S	Pediatric parallel smoothbore circuit 1.8M
REF: 263-1.6-12B/S	Pediatric parallel smoothbore circuit 1.6M
REF: 263-1.2-12B/S	Pediatric parallel smoothbore circuit 1.2M

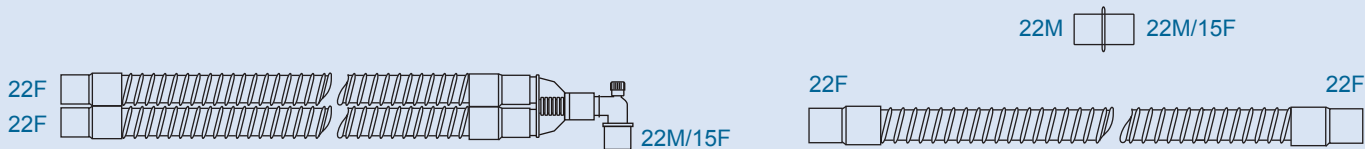

REF: 386-2.4-12B/S	Adult parallel smoothbore circuit 2.4M, 0.8 extra limb, 1pc extra connector
REF: 368-1.8-12B/S	Pediatric parallel smoothbore circuit 1.8M, 0.8 extra limb, 1pc extra connector

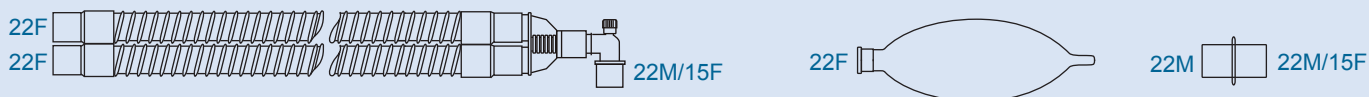

REF: 353-2.4-12B/S	Adult parallel smoothbore circuit 2.4M, 2L reservoir bag, 1pc extra connector
REF: 353-1.8-12B/S	Adult parallel smoothbore circuit 1.8M, 2L reservoir bag, 1pc extra connector
REF: 353-1.6-12B/S	Adult parallel smoothbore circuit 1.6M, 2L reservoir bag, 1pc extra connector
REF: 353-1.2-12B/S	Adult parallel smoothbore circuit 1.2M, 2L reservoir bag, 1pc extra connector
REF: 354-1.8-12B/S	Pediatric parallel smoothbore circuit 1.8M, 1L reservoir bag, 1pc extra connector
REF: 354-1.6-12B/S	Pediatric parallel smoothbore circuit 1.6M, 1L reservoir bag, 1pc extra connector
REF: 354-1.2-12B/S	Pediatric parallel smoothbore circuit 1.2M, 1L reservoir bag, 1pc extra connector

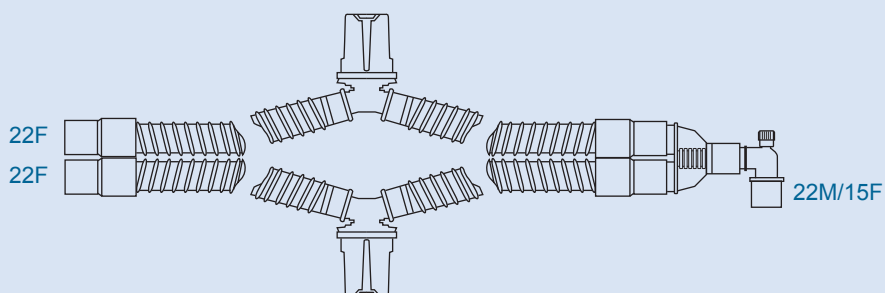

REF: 351-2.4-12B/S	Adult parallel smoothbore circuit 2.4M with two water traps
REF: 351-1.8-12B/S	Adult parallel smoothbore circuit 1.8M with two water traps
REF: 351-1.6-12B/S	Adult parallel smoothbore circuit 1.6M with two water traps
REF: 351-1.2-12B/S	Adult parallel smoothbore circuit 1.2M with two water traps
REF: 352-1.8-12B/S	Pediatric parallel smoothbore circuit 1.8M with two water traps
REF: 352-1.6-12B/S	Pediatric parallel smoothbore circuit 1.6M with two water traps
REF: 352-1.2-12B/S	Pediatric parallel smoothbore circuit 1.2M with two water traps

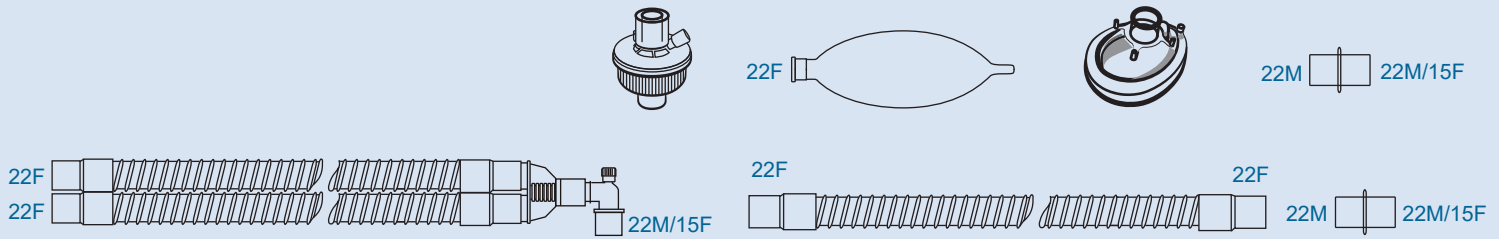

REF: 364-2.4-12B/S

Adult parallel smoothbore circuit 2.4M
 2L latex free reservoir bag, 2pcs extra connector, 1pc HME Filter, 1pc
 anesthesia mask 4.0, 1pc 0.8M extra limb

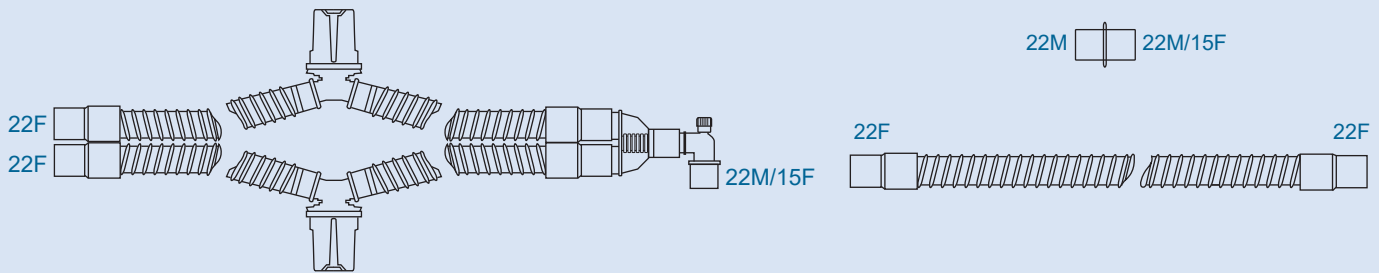

REF: 365-2.4-12B/S

Adult parallel smoothbore circuit 2.4M with two water traps,
 1pc extra connector, 1pc 0.8M extra limb

REF: 365-1.8-12B/S

Adult parallel smoothbore circuit 1.8M with two water traps,
 1pc extra connector, 1pc 0.8M extra limb

REF: 365-1.6-12B/S

Adult parallel smoothbore circuit 1.6M with two water traps,
 1pc extra connector, 1pc 0.8M extra limb

REF: 365-1.2-12B/S

Adult parallel smoothbore circuit 1.2M with two water traps,
 1pc extra connector, 1pc 0.8M extra limb

REF: 394-1.8-12B/S

Pediatric parallel smoothbore circuit 1.8M with two water traps,
 1pc extra connector, 1pc 0.8M extra limb

REF: 394-1.6-12B/S

Pediatric parallel smoothbore circuit 1.6M with two water traps,
 1pc extra connector, 1pc 0.8M extra limb

REF: 394-1.2-12B/S

Pediatric parallel smoothbore circuit 1.2M with two water traps,
 1pc extra connector, 1pc 0.8M extra limb

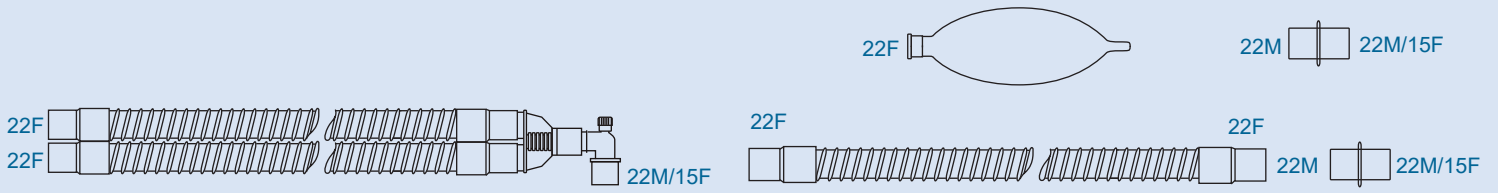

REF: 366-2.4-12B/S	Adult parallel smoothbore circuit 2.4M, 2L latex free reservoir bag, 2pcs extra connector, 1pc 0.8M extra limb
REF: 367-1.8-12B/S	Pediatric parallel smoothbore circuit 1.8M, 1L latex free reservoir bag, 2pcs extra connector, 1pc 0.8M extra limb

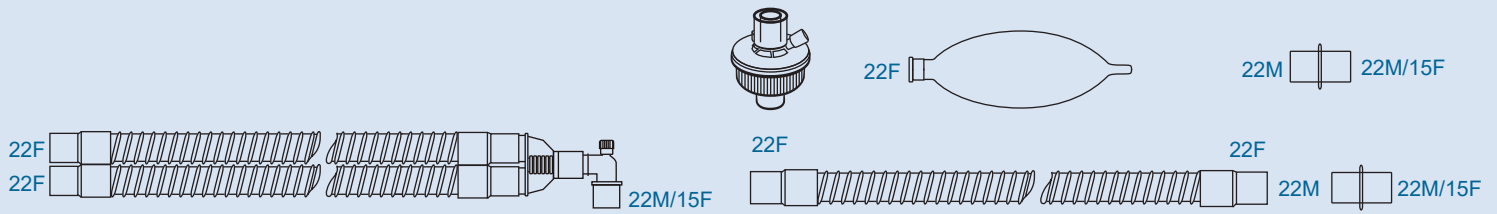

REF: 412-2.4-12B/S	Adult parallel smoothbore circuit 2.4M, 2L latex free reservoir bag 2pcs extra connector, 1pc HME Filter, 1pc 0.8M extra limb
REF: 413-1.8-12B/S	Pediatric parallel smoothbore circuit 1.8M, 1L latex free reservoir bag 2pcs extra connector, 1pc HME Filter, 1pc 0.8M extra limb

Name of parts for Anesthesia Breathing Circuit (coaxial circuit)

Anesthesia Breathing Circuit (coaxial circuit)		
Item No.	Name	Material
1	Elbow	PP
2	Connector	PP
3	Main tube	PP, EVA
4	T connector	PP
5	Side tube	PP,EVA
6	connector	PP

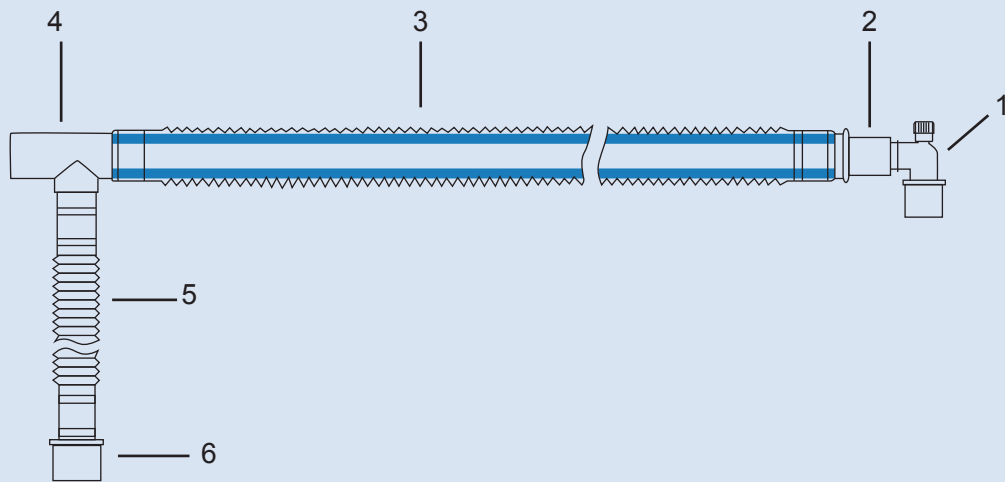

➤➤ Disposable Coaxial Circuits

Features:

- Coaxial breathing circuit is a convenient “tube within a tube” breathing system designed with low flow anesthesia in mind, offering warmer and more humid inspiratory gases, and the option of an integrated respiratory gases monitoring line.
- Match all kinds of anesthetic and breathing machines.
- Tube colors and length can be as required.

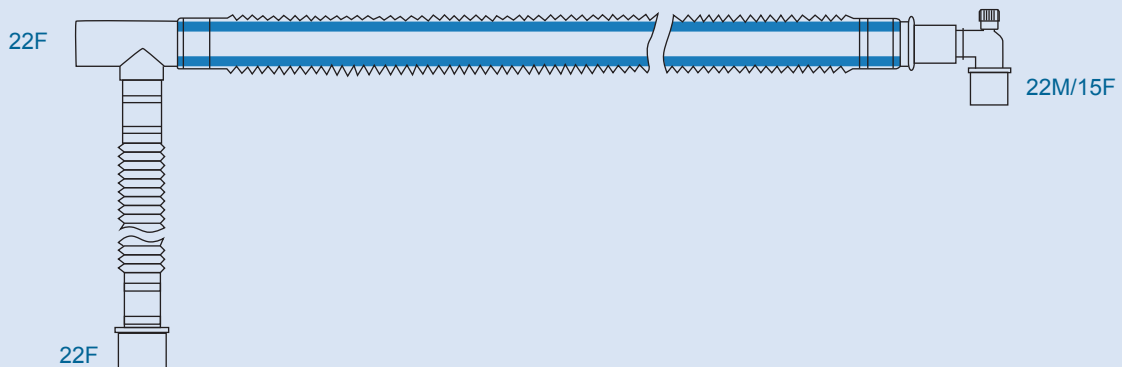

REF: 388-1.8-0.4-12B	Coaxial circuit 1.8M with 0.4M expandable tube
REF: 388-1.6-0.4-12B	Coaxial circuit 1.6M with 0.4M expandable tube
REF: 388-1.5-0.4-12B	Coaxial circuit 1.5M with 0.4M expandable tube
REF: 388-2.0-0.4-12B	Coaxial circuit 2.0M with 0.4M expandable tube

Name of parts for Anesthesia Breathing Circuit (duo-limb circuit)

Anesthesia Breathing Circuit (duo-limb circuit)		
Item No.	Name	Material
1	Elbow	PP
2	Connector	PP
3	Main tube	PP, EVA
4	T connector	PP
5	Side tube	PP,EVA
6	connector	PP

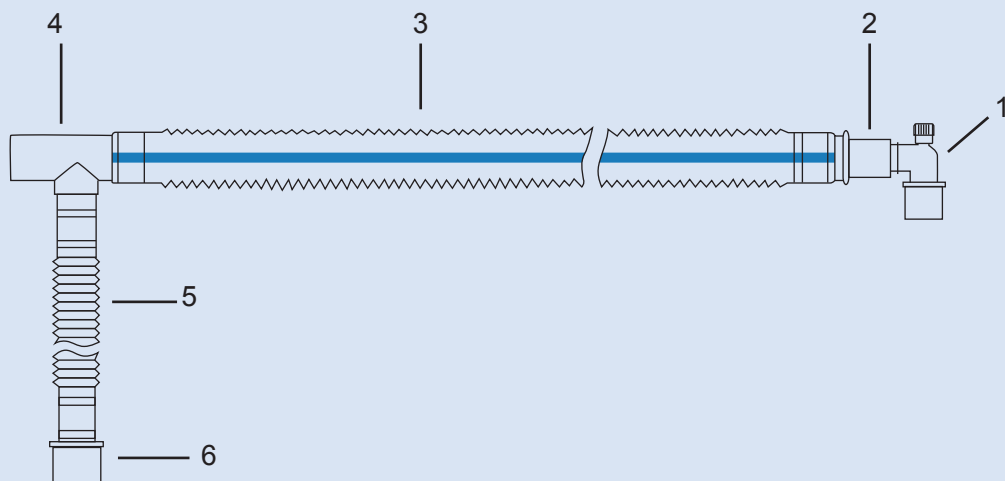

➤➤ Disposable Duo-limb Circuits

Features:

- Less weight than two-limb circuits, reduces torque on the patient's airway.
- With one single limb, offers more versatility when used as transport circuit and in the OR.
- Match all kinds of anesthetic and breathing machines.
- Tube colors and lengths can be as required.

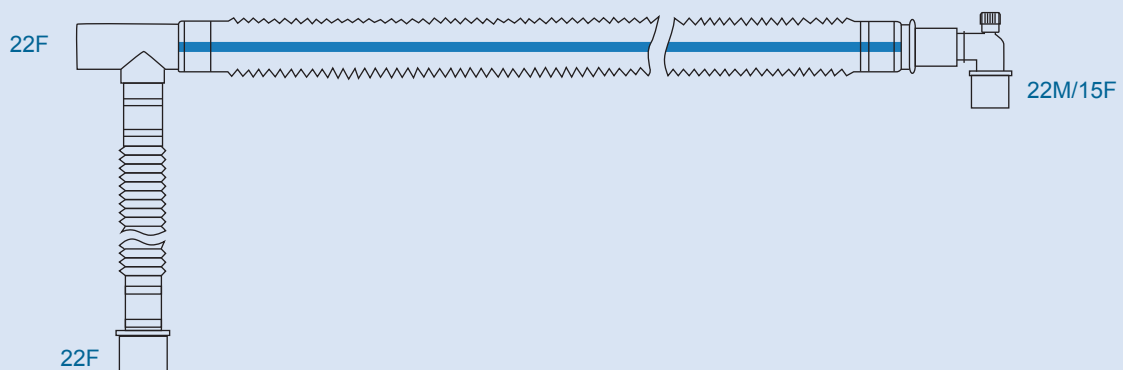

REF: 389-1.8-0.4-12B	Duo-limb circuit 1.8M with 0.4M expandable tube
REF: 389-1.6-0.4-12B	Duo-limb circuit 1.6M with 0.4M expandable tube
REF: 389-1.5-0.4-12B	Duo-limb circuit 1.5M with 0.4M expandable tube
REF: 389-2.0-0.4-12B	Duo-limb circuit 2.0M with 0.4M expandable tube

Performance :

1. Resistance to flow: at 30l/min, ≤ 0.2 kPa.
2. Leakage: at 6kPa, ≤ 10 ml/min.
3. Length: the actual length shall be within 10% of the designated length.

Caution

1. The operator for this product must be trained by professional training.
2. This product for single patient use only, please destroy it after use, please do not Re-sterilize it or use it once again.
3. Should be used immediately when opening the package, please destroy when it was used.
4. It is ban to use if the packing damaged, or packing be affected with damp, or the product went moldy.
5. This product is disposable, cannot be used again even after cleaning.
6. Single use only, Latex free.
7. Sterile or non-sterile, it can be as request.

Storage:

1. Store in a cool, dry and dark place. Avoid direct sunlight.
2. Should be stored indoor ventilation, and its space humidity is not more than 80%, no corrosive gas.

Anesthesia Breathing Circuit



Secured Medical Direction UK Co., Ltd.

Wayson Commercial Bldg 28 Con-naught Rd West Sheung Wan HK, P.R.C.



Secured Medical Direction UK Co., Ltd.

St. James House 13 Kensington Square W8 5HD London U.K.

www.smd-medical.com